

twentyfive50

change the way we work



PINNACLE

OFFICE FURNITURE

Rene Burger

c. 082 894 1788

f. 086 649 9239

e. rene.offurn@mweb.co.za
www.pinnacleofficefurniture.co.za



TWENTYFIVE50 BENCHING A WORKING SOLUTION

By observing and assessing the research and development both locally and internationally, the Twentyfive50 Benching System has been designed and developed to our exclusive design, and is manufactured locally at our technologically advanced manufacturing facilities. The Twentyfive50 Benching System is aesthetically light and balanced, and delivers creative solutions to a variety of space planning and functional needs.

The Twentyfive50 Benching System is a modular, easily configured and re-configured product, and is manufactured and assembled using a support beam based leg system, with additional architectural beams for supporting reticulation trays, screening, third level storage and accessories.

The Twentyfive50 Benching System simplifies facilities management, by integrating and optimizing effectively with all types of floor spaces. The ease of assembly / disassembly of the product, facilitates hassle - free installations, and frequent re-configurations, and creates productive working environments.

The minimal structure of the Twentyfive50 Benching System make workstations feel larger and more open, offering clear lines of sight, encouraging interactive teamwork, and improves communication.

The Twentyfive50 Benching System has an integrated cable management facility, that delivers convenient power and data to workstations. Power and data points can be located at workstation height, or just below, for easy access.



The Twentyfive50 Benching System is aesthetically light and balanced, and delivers creative solutions to a variety of space planning and functional needs. The workplace solution options inspire innovation, promote employee engagement and teamwork. Twentyfive50 offers a unique workplace identity that can express your organizational culture and brand and creates a productive work environment.

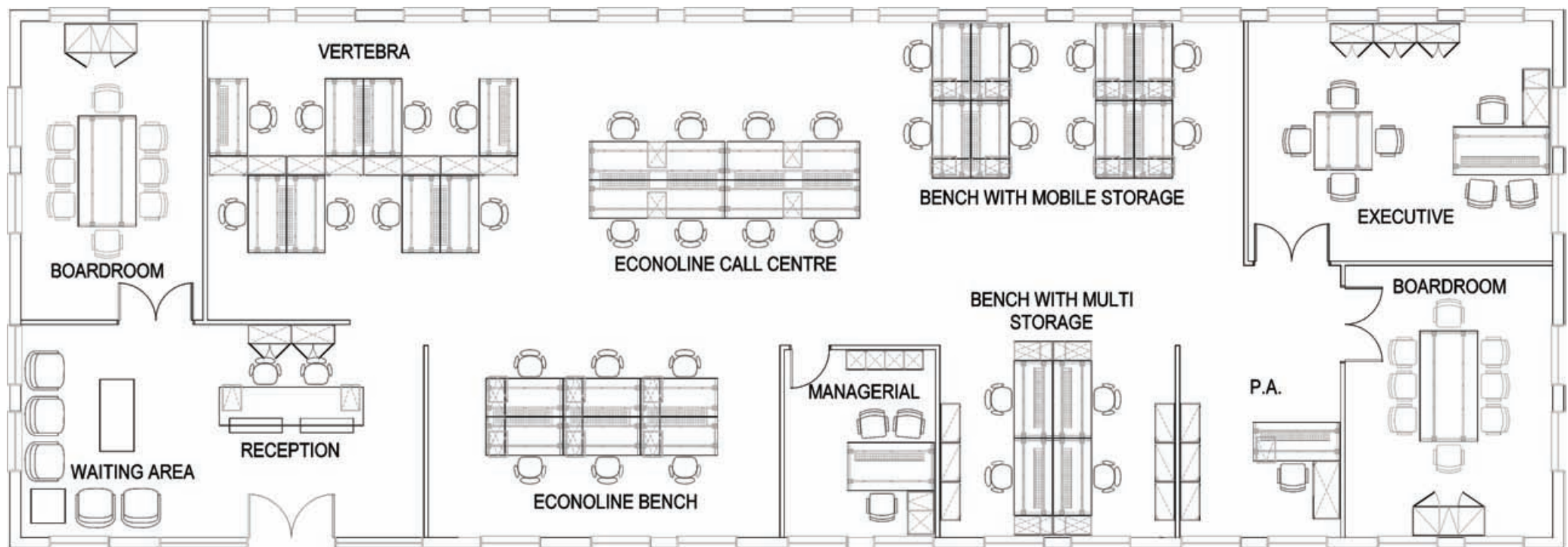

executive

03





personal assistant

05





vertebra

07



The Vertebra storage system offers the perfect solutions for all the storage functionality you need: Filing, Organization, Versatility and Space Utilization.

The Vertebra storage system is made up of a modular top storage unit, and bottom storage unit. The top storage unit is comprised of a pinboard section, and adjacent to the pinboard section, is a choice of either open storage or roller door storage compartments.

The bottom storage unit consists of a hinge door compartment, with a single shelf, and adjacent to the hinge door compartment, is a drawer unit consisting of 2 drawers (One single drawer, with a drop in pen and pencil tray and one drawer as a deep filer).

The Vertebra storage system has an integrated cable management compartment, placed between the top and bottom storage units, and is primarily used for reticulation purposes. Power and data cables are conveniently delivered to workstations through cable management ports, located on the sides, middle and back of the Vertebra storage units.

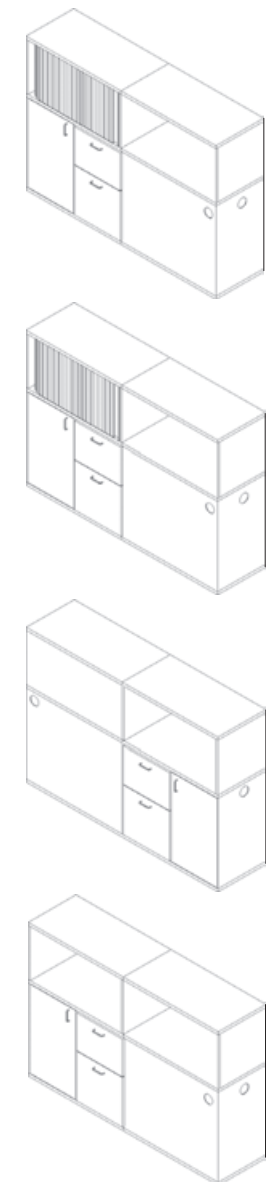
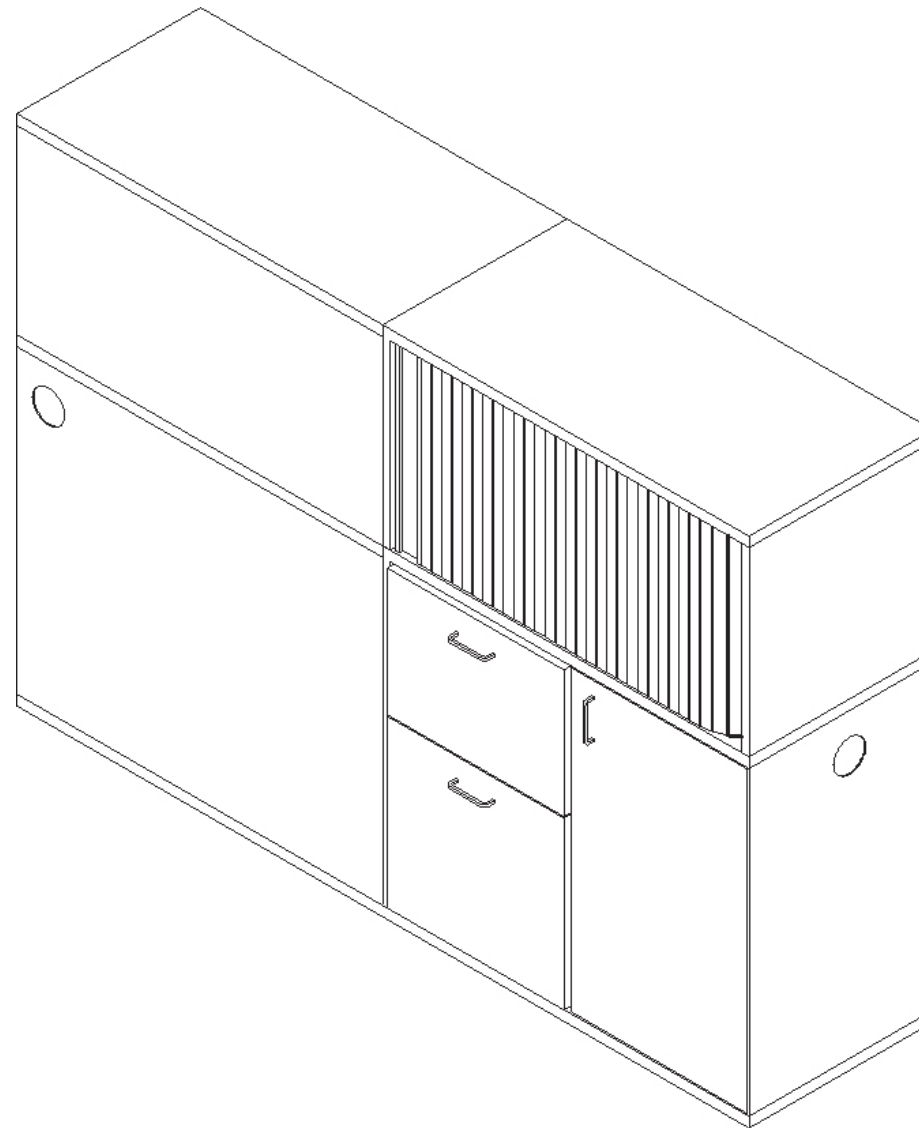

bench with multi storage

09



bench with mobile storage

10



bench with tallboy

11





econoline benching

13





reception

15





product list

17

twentyfive50 steel desking

	description	Size(w) x (d) x (h) Code
	executive desking - Freestanding - Adjustable Ferrules	2000 x 1000 x 730 DESK01
	managerial & pa desking - Managerial & PA size desk - Freestanding - Includes Wire Mesh Cable Tray - 2 Wire Management Portholes - Adjustable Ferrules	1800 x 900 x 730 DESK02 1800 x 750 x 730 DESK03 1600 x 750 x 730 DESK04 1200 x 750 x 730 DESK05
	dual desking - 2 x Workstations - Freestanding - Including Wire Mesh Cable Tray - 2 Wire Management Scallops - Adjustable Ferrules - Centre Leg on 1600,1800 & 2000	2000 x 1500 x 730 DESK06 1800 x 1500 x 730 DESK07 1600 x 1500 x 730 DESK08 1200 x 1500 x 730 DESK09
	L/extension - 600mm Leg & 2 Cross Beams - Beams Attach on Main Desk Beam - Fits onto all Straight, Dual & executive Steel Desks - Adjustable Ferrules	900 x 600 x 730 LEX01 1200 x 600 x 730 LEX02
	modesty panels steel - Includes Brackets - Power Coated Finish	1800 x 300 Z-MS009 1600 x 300 Z-MS010 1300 x 300 Z-MS011 1000 x 300 Z-MS012
	modesty panels wood - Includes Brackets & Screws	1800 x 300 MOD001 1600 x 300 MOD002 1300 x 300 MOD003 1000 x 300 MOD004
	surround trim steel frame screens - Steel Frame - Available in White (Standard), Silver or Black - 2 fabric panels fit into frame - Upholstered in Vulcan Fabric - Includes brackets	1800 x 400 Z-MS013 1600 x 400 Z-MS014 1300 x 400 Z-MS015 1000 x 400 Z-MS016

twentyfive50 econoline

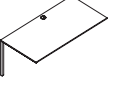
	description	Size(w) x (d) x (h) Code
	glass screens - Includes Brackets	1800 x 400 X-TFF1 1600 x 400 X-TFF2 1300 x 400 X-TFF3 1000 x 400 X-TFF4
	econoline straight (side by side) Must use 2x econoline pedestal with desks - 2 Workstations per Box - Fixes onto Slim Line Pedestal - Including wire mesh cable trays - 2 Wire Management Port - Adjustable levelling feet	1200 x 750 x 730 DESK10
	econoline dual A (side by side-4way) Must use 2x econoline pedestal with desks - 2 Dual A must be ordered to make 4 Way - Fixes onto Slim Line Pedestal - Including wire mesh cable tray - 2 Wire Management Ports - Adjustable Ferrules	1200 x 1500 x 730 DESK11 1600 x 1500 x 730 DESK12
	econoline straight desk (own pedestal) - Fixes onto Slim Line Pedestal - Including wire mesh cable tray - 1 Wire Management Port - Adjustable Ferrules	1200 x 1500 x 730 DESK13 1600 x 1500 x 730 DESK14
	econoline dual B (own pedestal-2way) - Fixes onto Slim Line Pedestal - Including wire mesh cable tray - 2 Wire Management Ports - Adjustable Ferrules	1200 x 1500 x 730 DESK15 1600 x 1500 x 730 DESK16
	1S1F econoline desk height pedesal - 2 Drawers & 1 Deep Filer - Drop in Pen & Pencil Tray - Drawers Central Locking - No Top	400 x 750 x 730 PED006Q
	slim line pedestal 2 door - 2 Hinge Door Storage Compartments - Doors Lockable - No Top	400 x 750 x 730 PED018



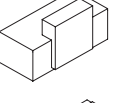
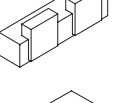
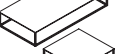



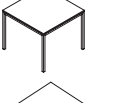
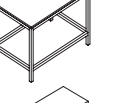
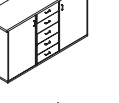
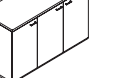





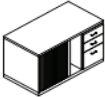







twentyfive50 welcome reception range

	description	Size(w) x (d) x (h) Code
	welcome reception unit - Single Station	1800 x 800 x 1100 TTFREC1 2000 x 800 x 1100 TTFREC2
	welcome reception unit - Double Station	3600 x 800 x 1100 TTFREC3
	salon coffee table - Steel Frame - Assembled - Floating Top	1200 x 600 TTFCOF1 800 x 600 TTFCOF2 800 x 800 TTFCOF3

twentyfive50 welcome reception range

	description	Size(w) x (d) x (h) Code
	boardroom table - 4 Cross Beams - 1 x Centre Leg for Stability on 2400 & 2700	1800 x 900 x 730 TFBOARD1 1800 x 1200 x 730 TFBOARD2 2400 x 1200 x 730 TFBOARD3 2700 x 1200 x 730 TFBOARD4
	meeting tables - 4 Cross Beams	1200 x 1200 x 730 TFMEET1 1600 x 1600 x 730 TFMEET2
	standing meeting table - 2 Cross Beams - Base Frame Structure	1800 x 900 x 900 TFMEET3 1600 x 900 x 900 TFMEET4
	server unit 2 door 5 drawer - Includes 2 Shelves - 2 Hinge Doors - 5 Drawers	1800 x 500 x 900 TTFSERV1
	server unit 3 door - Includes 3 Shelves	1800 x 500 x 900 TTFSERV2

twentyfive50 storage

	description	Size(w) x (d) x (h) Code						
	roller door credenza - Including 3/3 Shelf with shelf clips	500 x 730 x 1200 CRETF1		3S mobile pedestal with cushion - Central Locking - Drop in pen & pencil tray - Solid 22mm Base - 50mm Nylon Castor Wheels x5 - Weight bearing 40KG per Castor	550 x 595 x 400 PEDCUSH3		2S1F deep filer desk height pedestal - Including Top - Central Locking - Drop in pen & pencil tray	750 x 730 x 400 PED018
	pedenza - 2S1F Drawers - Drop in Pen & pencil Tray - 2/3 Shelf with shelf clips	500 x 730 x 1250 PEDTFF1		8 div pigeon organiser - 22mm Top & Bottom - Fits Lever Arch Files	500 x 1100 x 1500 PIG8DIV		2F deep filer desk height pedestal - Including Top - Central Locking - Drop in pen & pencil tray	750 x 730 x 400 PED019
	personal assistant organiser - For use on top of 1200 credenza	350 x 790 x 1200 PAO1		sliding door storage cabinet - 2 x 22mm laminate shelves - Lockable	500 x 1100 x 1500 CAB021		4S desk height pedestal - Including Top - Top locking only - Floating Pen & Pencil Tray in Top drawer	750 x 730 x 400 PED020
	wall unit base - Includes 1 Shelf	500 x 900 x 900 WUNBA		vertebra unit open top left / right hand side - 2 Way Storage unit - Cavity between Top & Bottom for Reticulation - Hidden Pen & Pencil Tray - Central Locking Drawers	450 x 1100 x 1800 VERTOPL (L) VERTOPR (R)		multi storage open top filer - Fits on top of Multi Storage unit - 22mm Top & Bottom	750 x 380 x 400 PBOOK3
	wall unit top with glass doors - No Lock - 2 Adjustable 22mm shelves	350 x 800 x 900 WUNTOPG		vertebra unit roller door top left / right hand side - 2 Way Storage unit - Cavity between Top & Bottom for Reticulation - Drop in pen & pencil tray - Central Locking Drawers	450 x 1100 x 1800 VERTDRL (L) VERTDRR (R)		multi storage roller door top filer - Fits on top of Multi Storage unit - 22mm Top & Bottom - Roller Door Only & Lockable	750 x 380 x 400 PBOOK4
	wall unit top open - 2 Adjustable 22mm shelves	350 x 800 x 900 WUNTOPO		1S1F mobile pedestal - Drop in Pen & Pencil tray - Central Locking - 4 Castor Wheels	550 x 595 x 400 PED002A		1S1F mobile pedestal with cushion - Central Locking - Drop in pen & pencil tray - Solid 22mm Base - 50mm Nylon Castor Wheels x5 - Weight bearing 40KG per castor	550 x 595 x 400 PEDCUSH
	1S1F mobile pedestal - Drop in Pen & Pencil tray - Central Locking - 4 Castor Wheels	550 x 595 x 400 PED002A		tall boy multi-storage left / right hand side - Pull out Storage unit - 2 x Drawers - Drop in pen & pencil tray - Lever Arch Filing compartment - Lockable - Wire Management portholes - Adjustable Ferrules	750 x 1100 x 450 TALLBOYL (L) TALLBOYR (R)		hinge door cabinet - 3/3 Shelf including shelf clips - Lockable	500 x 1500 x 1100 CAB006
	3S mobile pedestal - Drop in Pen & Pencil tray - Central Locking - 4 Castor Wheels	550 x 595 x 400 PED001A						



PINNACLE
OFFICE FURNITURE

Rene Burger

c. 082 894 1788

f. 086 649 9239

e. rene.offurn@mweb.co.za

www.pinnacleofficefurniture.co.za